

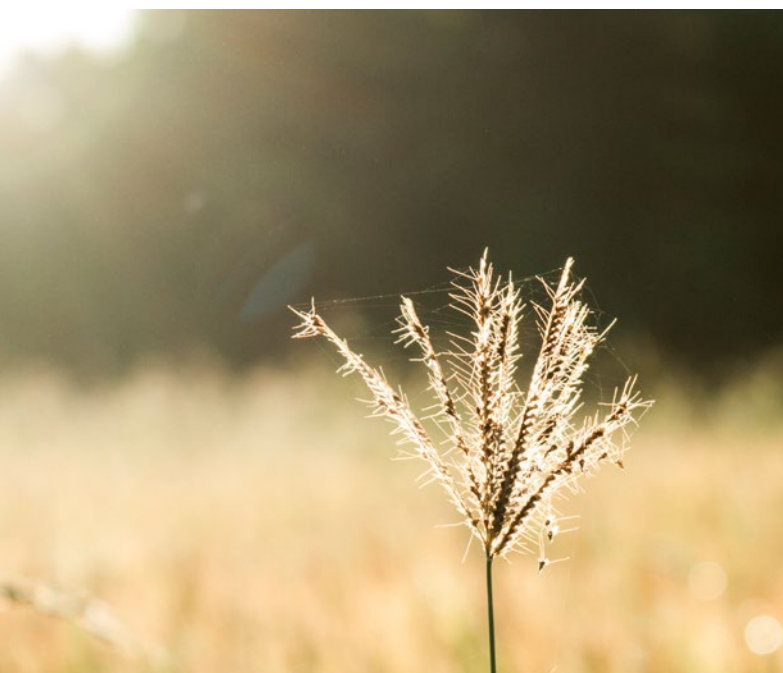

VL220 Whole Home Heat Recovery Ventilation





Lossnay Fresh Air Heat Recovery Ventilation

They say home is where the heart is. Because we spend so much time at home, the heart of the home should be as healthy as possible for your whole family. Clean, fresh air is paramount to good health and overall wellbeing.

Ventilation and Airtight Building Design

Creating a healthy living environment is important when renovating or building a new home – you will want the perfect indoor climate year-round. In addition to efficient heating and cooling, this should include the optimum amount of circulating fresh air.

Current building regulations now demand homes to be built more airtight as they are subjected to higher insulation standards. The option of leaving doors or windows open to allow more fresh air to enter is often not the solution from an outdoor noise or security perspective.

Ventilation, Condensation and Moisture Management

The lack of natural ventilation due to airtight spaces can lead to the build-up of moisture-laden stale air within the home. This is the perfect breeding ground for mould that can trigger allergy or respiratory problems.



Mould and dampness can compromise both building materials as well as furnishings inside the home.



Common places for mould to grow include window sills, curtains and carpets.

Lossnay is Designed for Today's Modern Homes

The word "Lossnay" originated from the Japanese word "Loss-Nai", meaning "No Loss". Lossnay is a patented Balanced Pressure Heat Recovery Ventilation System specifically designed for more airtight homes built to the current New Zealand Building Code. It also complies with the Ventilation Standard NZS4303:1990 that specifically requires ventilation systems to draw fresh air from the outside and not the roof space to achieve acceptable indoor air quality.

Bring Fresh Air in Without Draughts

The Lossnay VL220 is an advanced Heat Recovery Ventilation System that brings in filtered fresh outdoor air to replace stale indoor air. The optimum number of air changes are regulated to ensure there are no draughts, whilst minimising temperature fluctuations when additional fresh air is introduced. This is important as too many air changes will lead to dramatic drops in indoor temperature that require unnecessary additional heating.

Maximise Heat Recovery Even from Warm Damp Areas

With its unique and highly efficient heat recovery ability, the Lossnay system maximises recovery of the available heat energy from outgoing stale air, as well as heat energy contained in moist air from damp areas such as bathrooms, toilets and kitchens.

Pre-warm or Cool Air to Save on Your Power Bill

Recovered heat energy is utilised to pre-warm incoming air in winter or pre-cool incoming air in summer; providing savings on your heating or cooling bill. The end result is a healthier, drier and warmer/cooler home.



The Mitsubishi Electric Lossnay Difference

What makes the Balanced Pressure Lossnay VL220 Heat Recovery Home Ventilation System from Mitsubishi Electric so different from other systems is our advanced Diamond Lossnay Core at the heart of the heat exchanger.



The patented highly efficient Diamond Lossnay Core is designed to maximise heat recovery from both stale outgoing air as well as heat energy contained in warm damp air from areas such as bathrooms, toilets and kitchens.



The available energy is absorbed and re-used to provide pre-warming in winter or pre-cooling in summer, rather than going to waste by directly transferring this air outside. In doing so, moisture build-up in your home is minimised while healthy humidity levels are maintained and managed.



The end result: your home is ventilated with fresh, filtered and pre-warmed (or cooled) air whilst maintaining optimum humidity levels for healthy living. The Lossnay system is super energy efficient and designed specifically to be whisper quiet.

FEATURES

- ✓ Draws in fresh air from the outside not the attic
- ✓ Removes stale air from the inside
- ✓ Circulates fresh air without draughts
- ✓ Heat recovery from stale outgoing air
- ✓ Efficient heat recovery from damp areas
- ✓ Whisper quiet operation from 14dB
- ✓ Balanced Pressure Ventilation

Why Outside Air, Not Attic Air?

Not all air is created equal. Lossnay only draws fresh air from the outside – it does not draw air from the attic. The absence of significant air movement common in attics means the air is likely to be stale. In addition, build-up of dust, dirt and other contaminants such as mould, insect and rodent droppings makes this air much harder to filter before it is distributed through your home. This is why the Balanced Pressure Lossnay System specifically utilises direct fresh air instead.





How It Works

The Balanced Pressure Lossnay Heat Recovery Ventilation System removes stale, dirty air and draws in fresh air from outside. Lossnay also recovers heat energy from the air being transferred to pre-warm (or pre-cool) the fresh air being drawn into your home. The VL220 model is ideal for small to medium sized homes between 52m² and 192m².

1. The stale air extracted from your home is Return Air (RA). Return Air can contain high levels of CO₂, odours and other pollutants. This Return Air stream also contains heat energy that Lossnay can recover, which is not the case with positive pressure ventilation systems.
2. As the stale Return Air is removed, Lossnay's core 'recovers' the useful heat energy from it. The air is then exhausted (EA) outside along with the unwanted pollutants.
3. Outdoor Air (OA) is introduced to provide fresh air. It is first filtered, then passed through the Lossnay core. This allows it be pre-heated in winter (or pre-cooled in summer) using the energy recovered from the Return Air.
4. Supply Air (SA) then enters your house as fresh pre-heated or pre-cooled air.

- 
EXTRACTS STALE AIR
 Extracts stale air removing toxins and reducing humidity.
- 
SUPPLIES FRESH AIR
 Supplies fresh air increasing the oxygen levels in the home and assists with managing the build-up of moisture.
- 
HEAT RECOVERY
 Recovers up to 86% of the heat energy from the outgoing air to preheat the incoming air, saving you money.

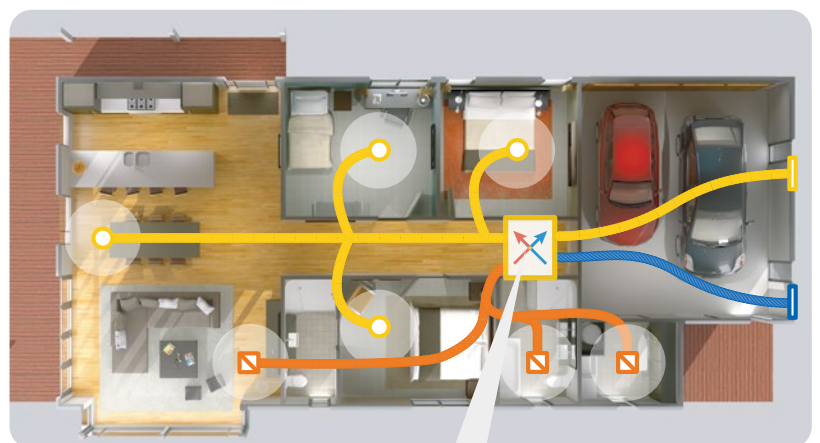

How Fresh Air Heat Energy Recovery Works

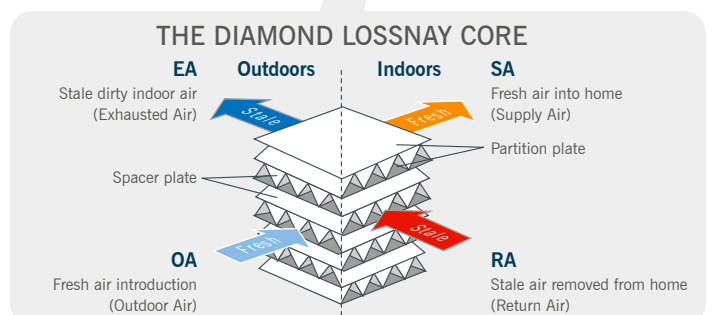
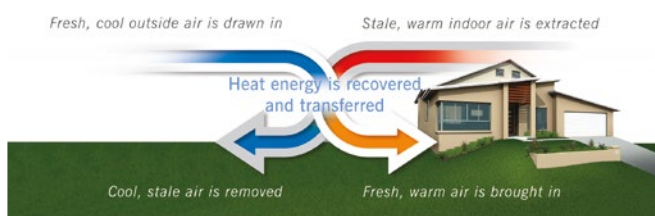

Balanced Pressure Heat Recovery Ventilation Benefits

Ventilating your home is vital as it maintains air quality and reduces moisture, creating a healthier and more comfortable environment. The Mitsubishi Electric Lossnay System is a patented heat recovery ventilation solution that uses fresh air (not attic air) to ventilate your home. The system works by extracting stale air from inside your house and replacing it with allergen-reduced fresh air from outside.



Improved Air Quality

By drawing in fresh outdoor air, indoor air quality is improved as high levels of CO₂, odours and other pollutants are removed from your home.

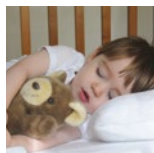

Creates a Healthier Home

Filtered fresh air improves air quality for allergy and asthma sufferers.

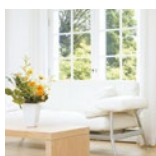

Fresh Air Without Open Windows

Lossnay allows you to have a well-ventilated home without the need to open windows. This improves the safety of your home and family and means outdoor noise is minimised.

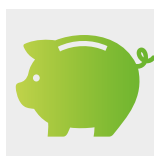

Energy Efficient

Incoming fresh air is pre-warmed so your heating system isn't required to work as hard to reach desired temperature. This is highly energy efficient, and can help reduce heating bills.



Retains Heat

Lossnay's unique Heat Recovery Technology collects up to 86% of the heat energy in outgoing air which is then used to pre-warm or cool the fresh air vented in.

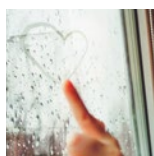

Assists Moisture and Condensation Control

Lossnay effectively reduces moisture in your home by directly removing stale air that causes condensation via the Lossnay core.

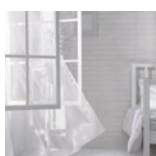

Balanced Pressure, No Draughts

Lossnay is specifically designed for more airtight homes built to the current New Zealand building code; bringing in the optimum amount of fresh air without creating draughts and minimising indoor temperature fluctuations.



Easy Control At Your Finger Tips

An intuitive wall controller with easy-to-read LCD display comes standard. Fan speed, night set back and 24-hour and weekly timers can easily be customised and programmed with up to 8 stop and start patterns per day.

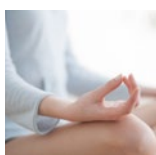

Quietest in its Class

At an ultra quiet 14dB in low fan speed, the Lossnay VL220 is the quietest system in its class.



Easy To Clean

The standard filters can be removed for regular cleaning to keep the unit in optimal working condition.

Positive Pressure Roof Cavity Ventilation

These systems typically force air into the home from the attic space and specifically require gaps in the building structure (common in older homes) to facilitate air displacement.

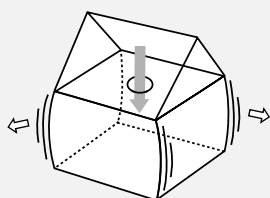

Air goes in and is forced out through the building gaps

VS

Balanced Pressure Fresh Air Heat Recovery Ventilation

Balanced Pressure Ventilation systems work by mechanically extracting stale, moisture-laden air from the home and replacing it with fresh, outdoor air at the same rate. These systems can work with both older and modern homes but are most effective for homes built to a high airtight standard.

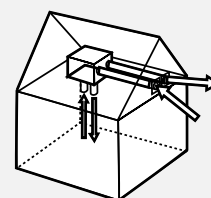

Fresh air goes in while stale air is extracted out

Lossnay VL220 Technical Specifications

Sample Installation

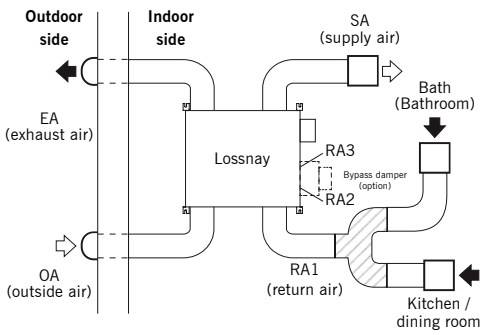

Dimensions

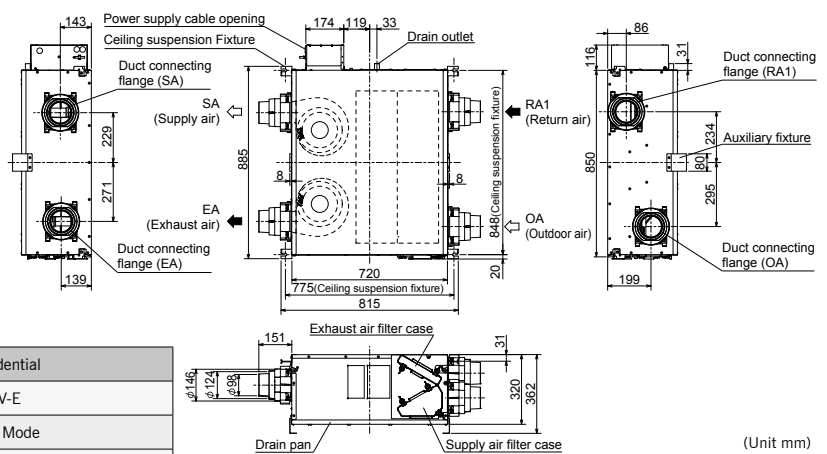

Type	Lossnay - Residential				
Model	VL-220CZGV-E				
Ventilation Modes	Heat Recovery Mode				
Heat Exchange System	Air to Air Sensible Heat Exchanger				
Heat Exchange Element Material	Specially Treated Non-permeable Resin Core				
Surrounding Air Condition	Between 0°C and 40°C, 80%RH or less				
Return (Suction) Air Condition	Up to 40°C, 95%RH				
Supply Fan Operation Under Low Outdoor Temperature	0°C to -5°C: Intermittent operation 24 min ON, 6 min OFF. -5°C or less: Continuous supply air stopped.				
Weight (kg)	31				
Electrical Power Supply	220-240 V / 50Hz 220V / 60 Hz				
Fan Speed	Fan Speed 4	Fan Speed 3	Fan Speed 2	Fan Speed 1	
Input Power (W)	80	35	18.5	8.5	
Air Volume	(m³/h)	230	165	120	65
	(L/s)	64	46	33	18
External Static Pressure (Pa)	164	84	44	13	
Temperature Exchange Efficiency (%)	82	84	85	86	
Noise (dB) (Measured at 1.5m under the centre in an anechoic chamber)	31	25	19	14	
Duct Size	150mm				

Characteristic Curve

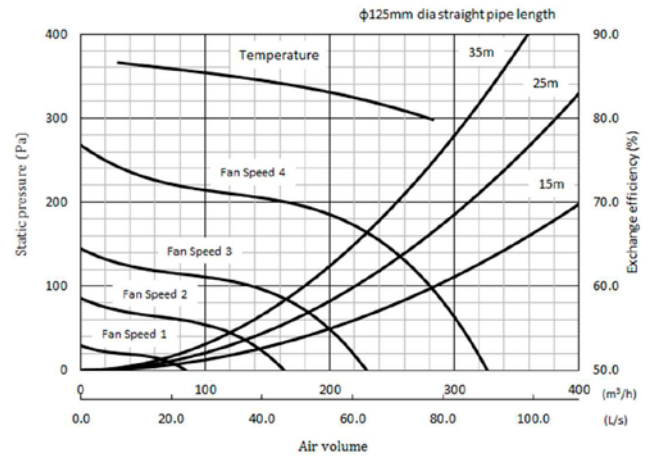

Please note: When deciding on the best place to position the Lossnay Ventilation System, care needs to be taken to not have incoming air intake near or close to a wood burner flue.

Optional VL220 Extras

Filters

The VL220 Ventilation system is supplied with 2 standard (G3) filters [1 supply, 1 exhaust] that can be washed up to 4 times. The supply filter can be upgraded to the P-220SHF-E option, a non-washable high efficiency filter (M6 grade). The exhaust filter can be upgraded to the P-220EMF-E option, a non-washable medium efficiency filter (G4 grade).

Bypass Damper

The optional damper allows a bypass of the heat exchanger should temperature conditions reach set levels. This can be used for free cooling* during the summer months.

* In comparison to using a dedicated cooling device. The unit will continue to use a small amount of power to bring colder fresh air from outside.

Exhaust Fans

Mitsubishi Electric offer a range of energy efficient exhaust fans that feature low vibration and quiet operation – ideal for the extraction of moisture and contaminants in bathrooms and kitchens. These exhaust fans are designed to specifically work in harmony with the Lossnay VL220 system.

5 Year Warranty

The Mitsubishi Electric Lossnay product in this brochure comes with a full 5 year parts and labour warranty. Warranty conditions apply.