

Installation guide – Spare parts and accessories

Repair kit | Code number 148B6067
SVA-S/L, SVA-ST/LT, SVA-HS, SCA/X size 125

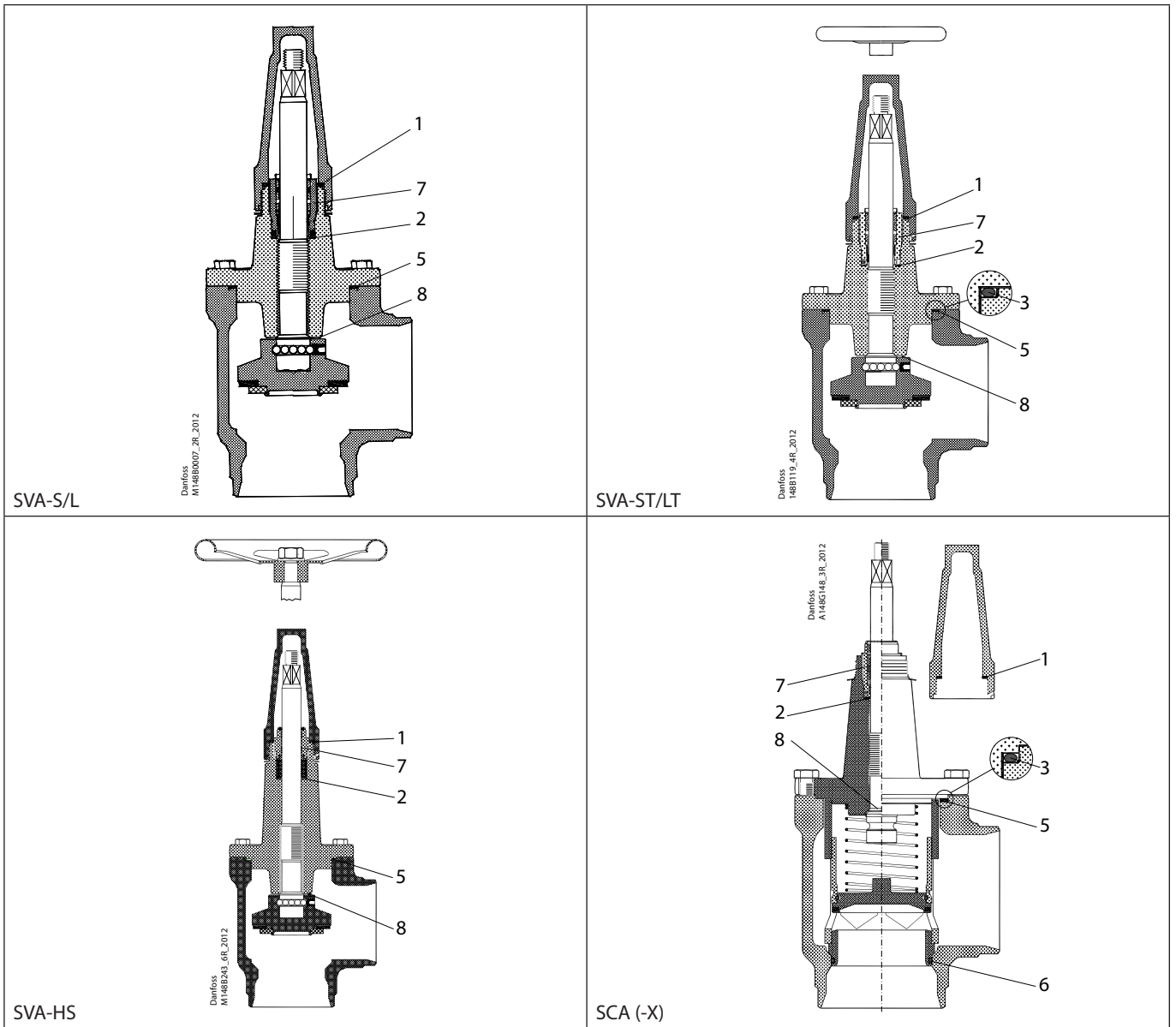

<p>1</p> <p> = Nylon</p> <p>Total no. = 1</p>	<p>2</p> <p> = Alu.</p> <p>Total no. = 1</p>	<p>3</p> <p>Total no. = 1</p>	<p>5</p> <p> = Fibre</p> <p>Total no. = 1</p>	<p>6</p> <p>Total no. = 1</p>
<p>7</p> <p>Total no. = 1</p>	<p>8</p> <p> = PTFE</p> <p>Total no. = 1</p>			

NOTE: When replacing the packing gland (pos. 7) in SVA-ST, SVA-S/L, SVA-HS, SCA-X and SCA the aluminium gasket (pos. 2) is needed.