

Installation guide – Spare parts and accessories

Overhaul kit | Code number 148B6156
SVA-S/L, SVA-ST/LT, SVA-HS, size 100

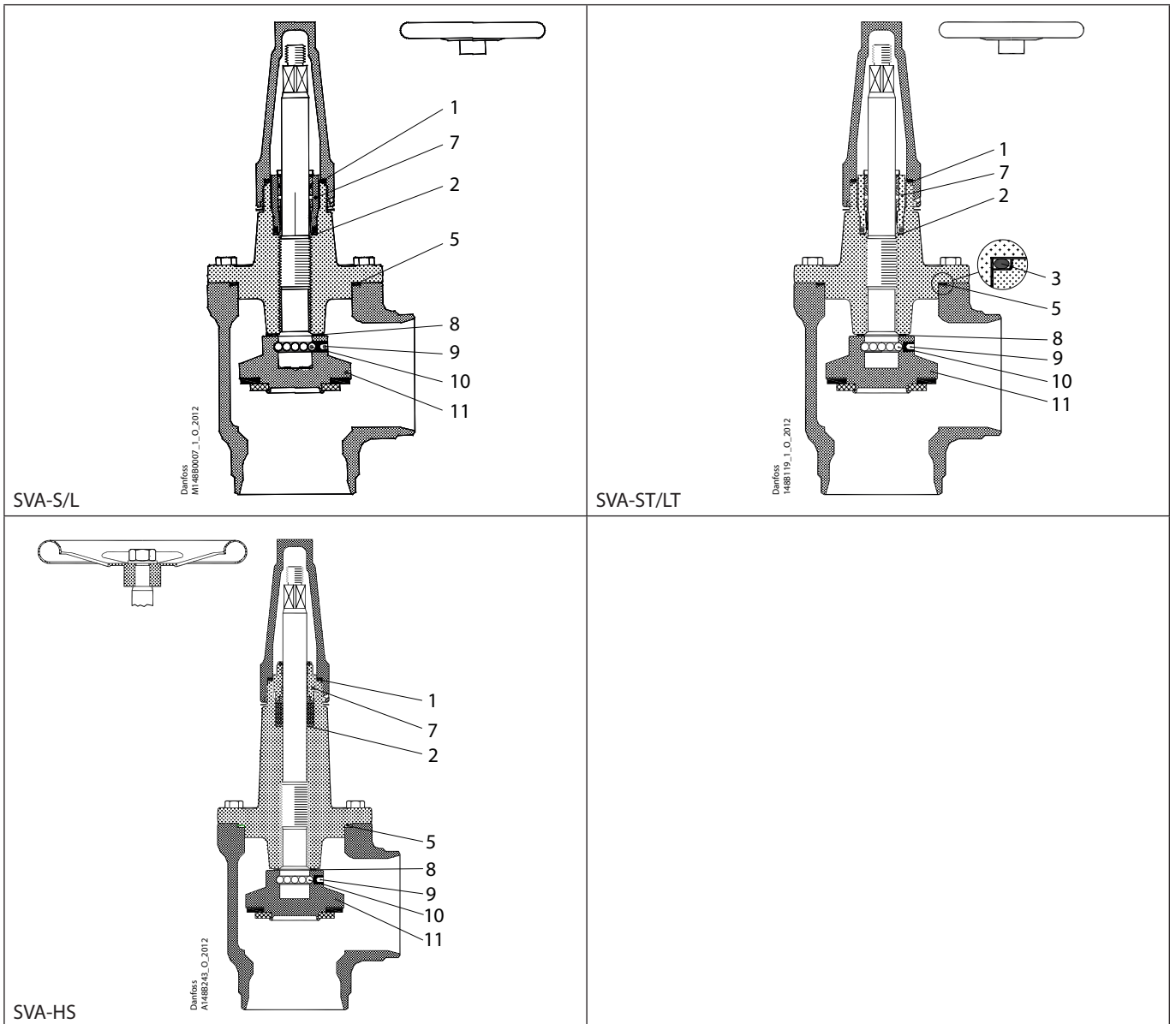

<p>1</p> <p> = Nylon</p> <p>Total no. = 1</p>	<p>2</p> <p> = Alu.</p> <p>Total no. = 1</p>	<p>3</p> <p>Total no. = 1</p>	<p>5</p> <p> = Fibre</p> <p>Total no. = 1</p>	<p>7</p> <p>Total no. = 1</p>
<p>8</p> <p> = PTFE</p> <p>Total no. = 1</p>	<p>9</p> <p>Total no. = 1</p>	<p>10</p> <p>Total no. = 13</p>	<p>11</p> <p>Total no. = 1</p>	<p>12</p> <p>Total no. = 1</p>

NOTE: When replacing the packing gland (pos. 7) in SVA-S/L, SVA-ST/LT or SVA-HS the aluminium gasket (pos. 2) is needed.