

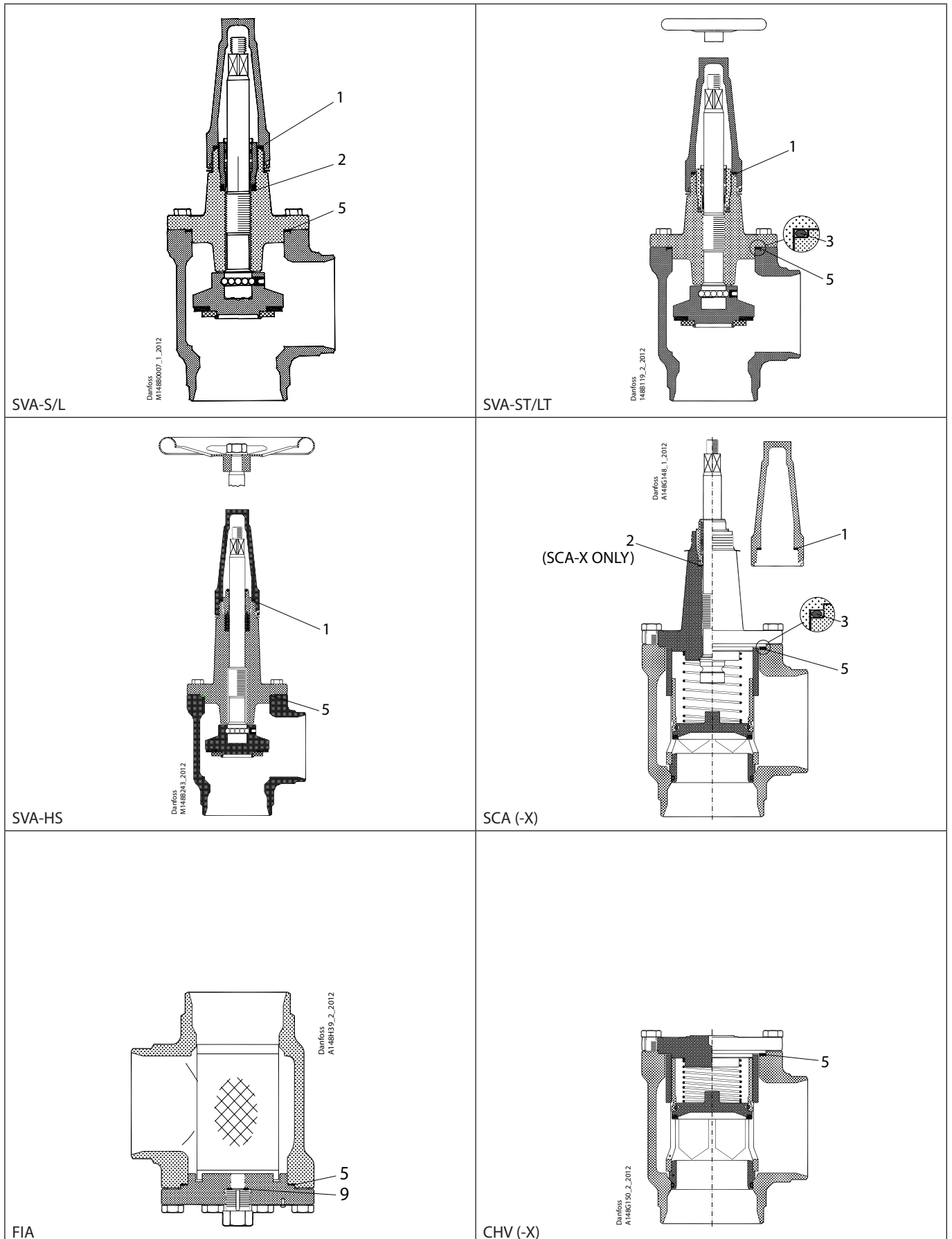









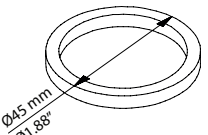

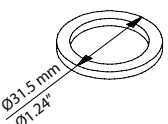
Installation guide – Spare parts and accessories

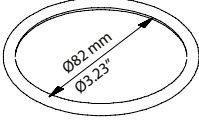
Inspection kit | Code number 148B6055

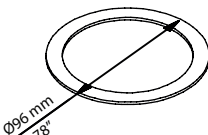
SVA-S/L, SVA-ST/LT, SVA-HS, SCA/X, FIA, CHV/X size 80

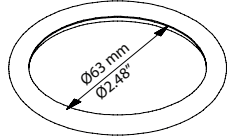

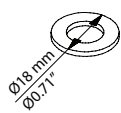
<p>1</p> <p> = Nylon</p>  <p>Ø45 mm Ø31.5 mm</p> <p>Total no. = 1</p>	<p>2</p> <p> = Alu.</p>  <p>Ø31.5 mm Ø24 mm</p> <p>Total no. = 1</p>	<p>3</p>  = Alu.  <p>Ø82 mm Ø63 mm</p> <p>Total no. = 1</p>	<p>5</p> <p> = Fibre</p>  <p>Ø96 mm Ø78 mm</p> <p>Total no. = 1</p>	<p>6</p>  = Alu.  <p>Ø63 mm Ø48 mm</p> <p>Total no. = 1</p>
<p>9</p> <p> = Alu.</p>  <p>Ø18 mm Ø11 mm</p> <p>Total no. = 1</p>				