

Installation guide – Spare parts and accessories

Overhaul kit | Code number 027H4180
 ICM, size 40A

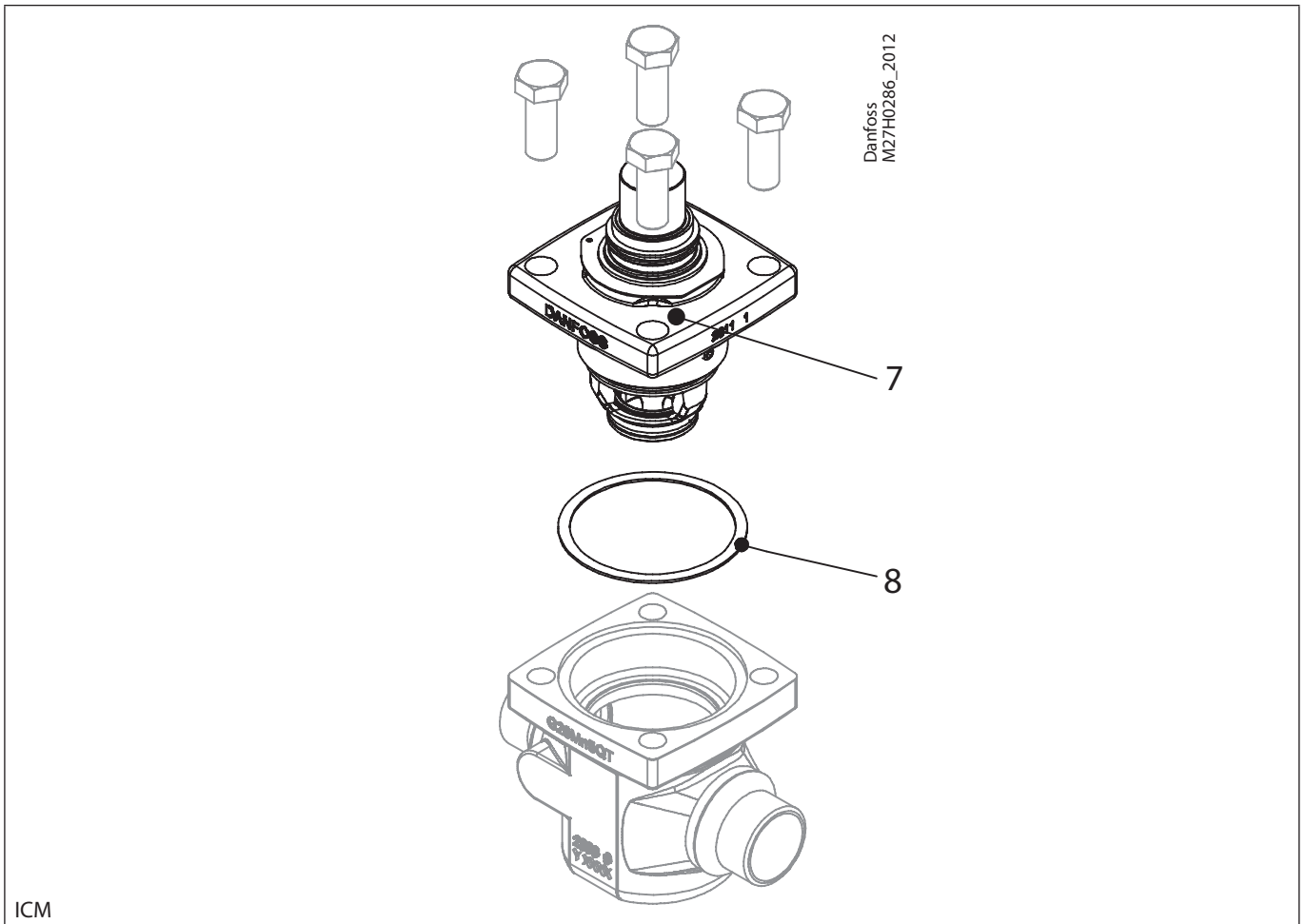

ICM

