

Installation guide – Spare parts and accessories

Overhaul kit | Code number 148B6163

SCA / SCA-X sizes 65

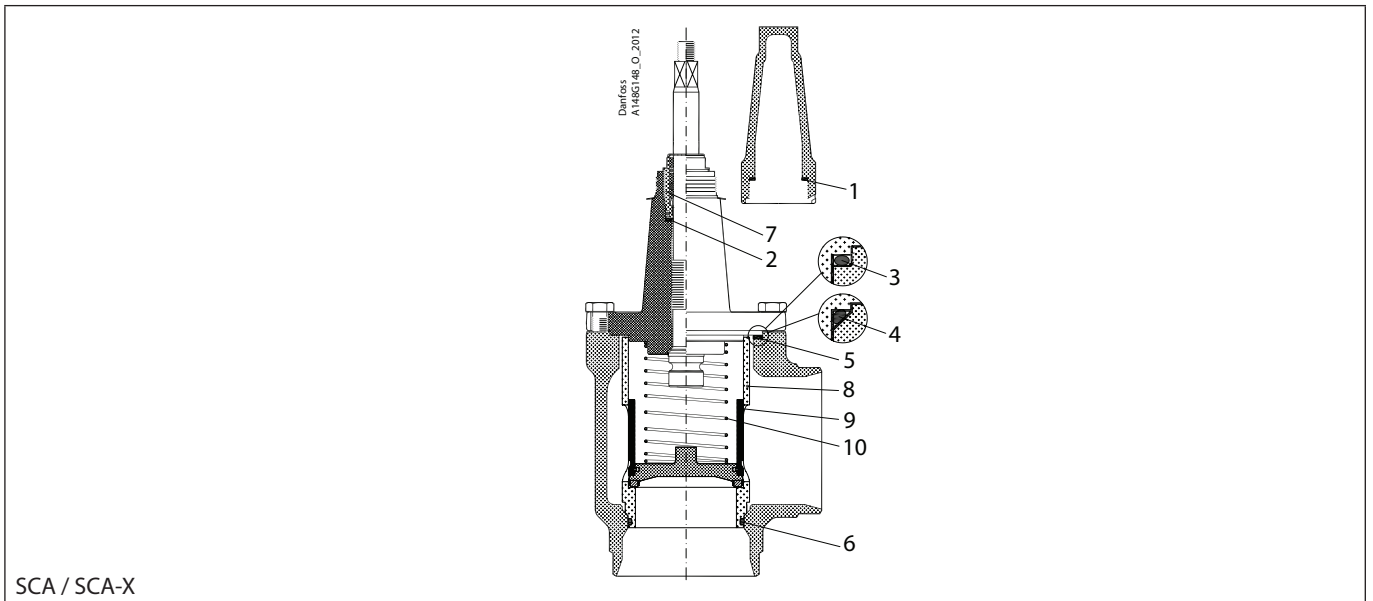

SCA / SCA-X

<p>1</p> <p> = Nylon</p> <p>Total no. = 1</p>	<p>2</p> <p> = Alu.</p> <p>Total no. = 1</p>	<p>3</p> <p>Total no. = 1</p>	<p>4</p> <p>Total no. = 1</p>	<p>5</p> <p> = Fibre</p> <p>Total no. = 1</p>
<p>6</p> <p>Total no. = 1</p>	<p>7</p> <p>Total no. = 1</p>	<p>8</p> <p>Total no. = 1</p>	<p>9</p> <p>Total no. = 1</p>	<p>10</p> <p>Total no. = 1</p>

NOTE:

When replacing the packing gland (pos. 7) in SCA-X or SCA the aluminium gasket (pos. 2) is needed.